

MOVING YOUR BUSINESS **FORWARD.**

In-house production of conveyor belts with cleats according to the client's requirements.

We offer a wide selection of conveyor belts, rollers, motor rollers, chains, pulleys and other drive components.

By choosing Schiki Belting technology, you will not only reduce your supplier base, but you will also have access to our global network of product and industry experts.

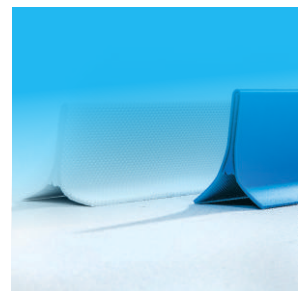
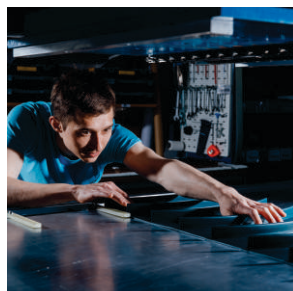

Custom-made conveyor belts with cleats



We offer a wide selection of different materials that will meet user requirements for light and more demanding processing and transport tasks. We offer open conveyor belts, belts with mechanical fasteners and classic conveyor belts with hot welded joints.

With our special technology, we have greatly improved the production of joints, so that joints can be produced in just a few minutes and thereby shortening machine downtime.

Our conveyor belt manufacturing includes the latest high-performance machines such as high-frequency welding machines, digital cutting machines, CNC machines and high-performance presses for high-quality custom-made conveyor belts.

We also offer new series of materials that do not contain fabrics, so they are even more compliant with the standards in the food industry.

24/7 service

We provide our customers with 24/7 on-site conveyor belt and belt splicing services. Contact our qualified staff and we will provide you with the right solution for your production process.





SCHIKI

MOVING YOU FORWARD.

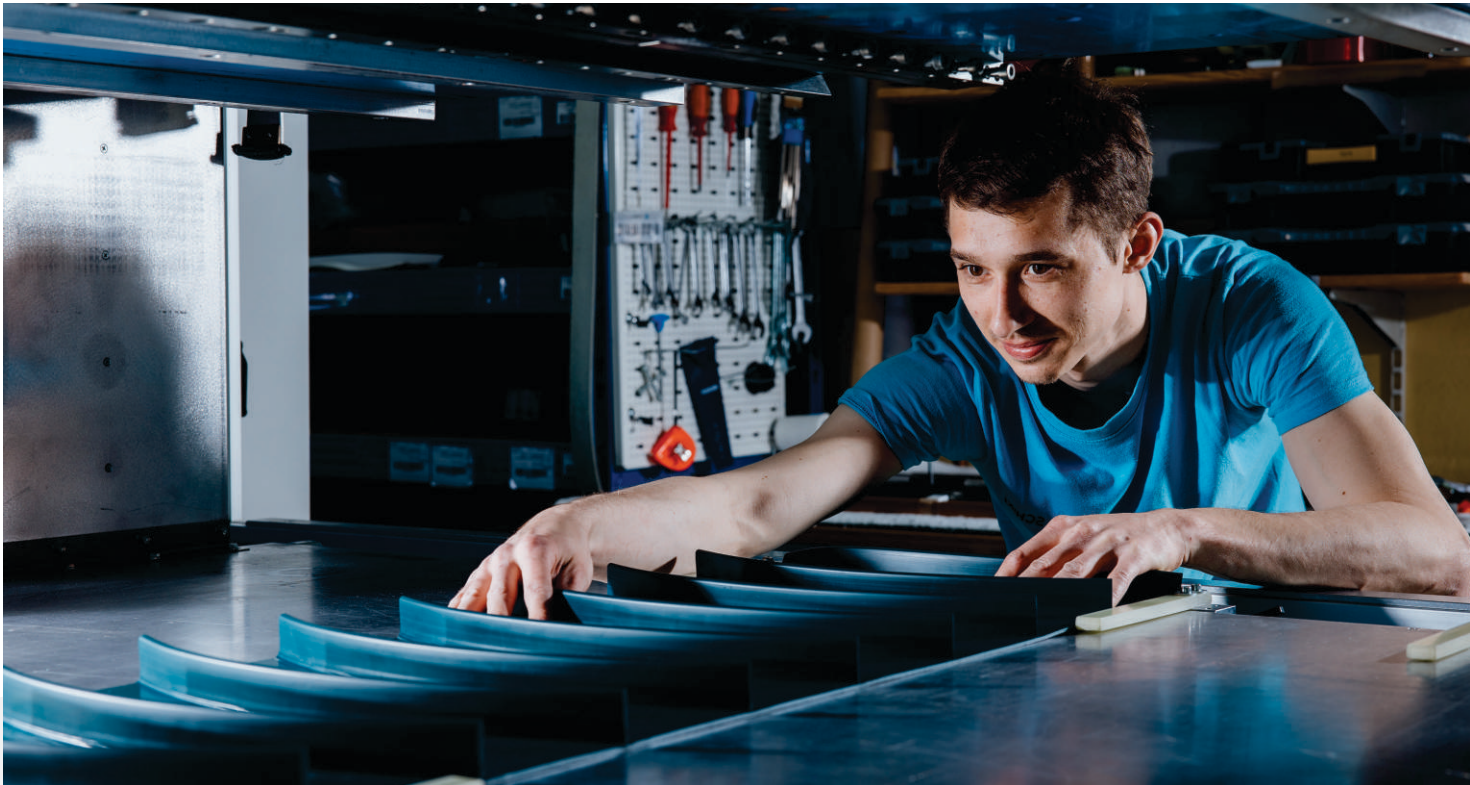

PVC CLEATS

- Good chemical resistance (also chlorine) |
- Resistance to hydrolysis (hot water and steam) |
- Flame retardant types available (ISO 340) |
- Types available suitable for food contact (dry foods) |
- Good prices |
- Available in many hardnesses, profiles and colors |

- Good resistance to oil and grease |
- Suitable for contact with all food |
- Available in white and light blue and with different profiles |

PVC CLEATS



NT

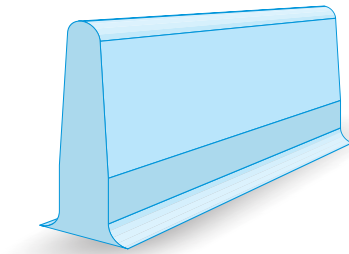
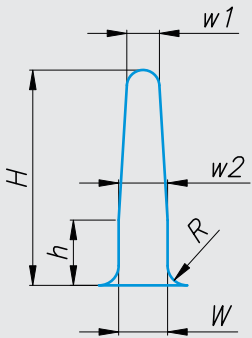

Colors available:

- White
- Petrol
- Apple green
- Dark green
- Light blue
- Dark blue
- Black

* on request

	NT20	NT30	NT40	NT50	NT60	NT75	NT100
H	20	30	40	50	60	75	100
w1	4,5	5	6	7	8	9	11
w2	6	7,5	9,5	11,5	11,5	16	20,5
h	10	10	10	10	10	10	10
R	3	3	3	3	3	3	3
**D drum	30	40	50	60	70	90	120

NH

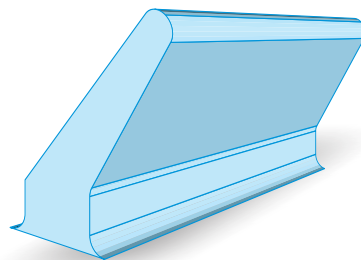
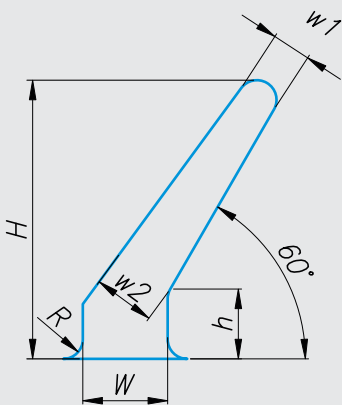

Colors available:

- White
- Petrol
- Apple green
- Dark green
- Light blue
- Dark blue
- Black

* on request

	NH30	NH40	NH50	NH60	NH75	NH100
W	10,5	13	15	17	19,5	24,2
H	30	40	50	60	75	100
w1	5	6	7	8	9	11
w2	7,5	9,5	11,5	11,5	16	20,5
h	10	10	10	10	10	10
R	3	3	3	3	3	3
**D drum	40	50	60	70	90	120

*all dimensions are in mm

**min. drum flexing

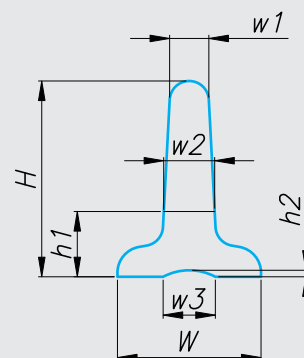
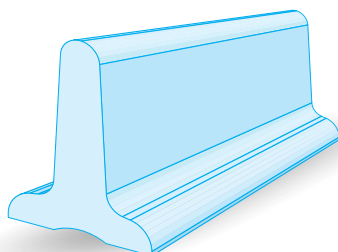

	T20	T30	T40	T50	T60	T75	T100
W	20,5	22	23,5	25,5	37,5	39,5	45
H	20	30	40	50	60	75	100
w1	5	6	7	8	9	10,5	13
w2	5,8	7,8	9,8	11,1	13,3	16,5	20,3
w3	7	8	8	8	18	18	18
h1	10	10	10	10	10	10	10
h2	1	1	1	1	1,5	1,5	1,5
**D drum	50	80	90	100	120	160	220

Colors available:

- White
- Petrol
- Apple green
- Dark green
- Light blue
- Dark blue
- Black

* on request

T-RF

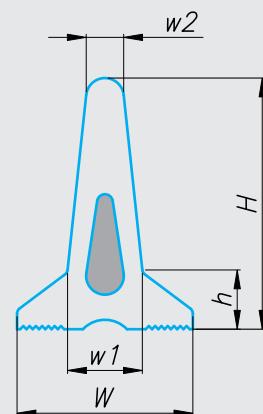
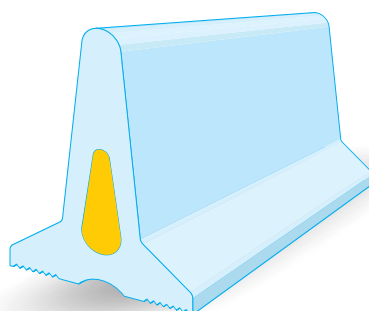

	T-RF30	T-RF40	T-RF50	T-RF60	T-RF70	T-RF80
W	28	28	28	28	28	28
H	30	40	50	60	70	80
w1	11	11	11	11	11	11
w2	7	7	7	7	7	7
h1	10	10	10	10	10	10
**D drum	90	100	120	140	160	180

Colors available:

- White
- Petrol
- Apple green
- Dark green
- Light blue
- Dark blue
- Black

* on request

*all dimensions are in mm

**min. drum flexing

PVC CLEATS



H

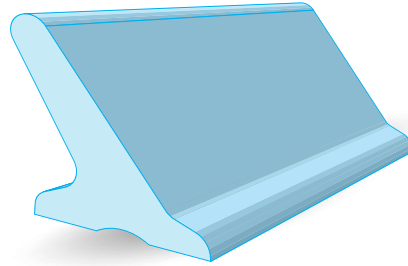
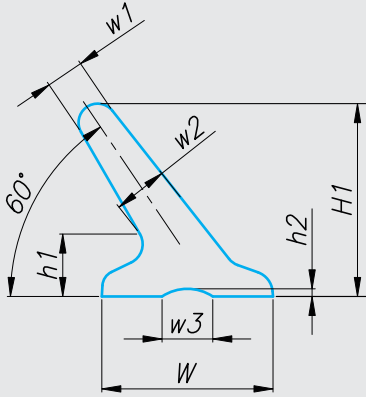

Colors available:

- White
- Petrol
- Apple green
- Dark green
- Light blue
- Dark blue
- Black

* on request

	H30	H40	H50	H60	H75	H100
W	26,5	28,5	30,5	40,5	45	50
H	30	40	50	60	75	100
w1	6	7	8	9	10,5	13
w2	8,3	10	10,4	13,4	16,1	20,2
w3	8	8	8	18	18	18
h1	10	10	10	10	10	10
h2	1	1	1	1,5	1,5	1,5
**D drum	80	110	130	150	180	250

H-10

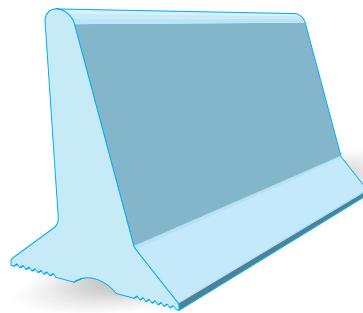
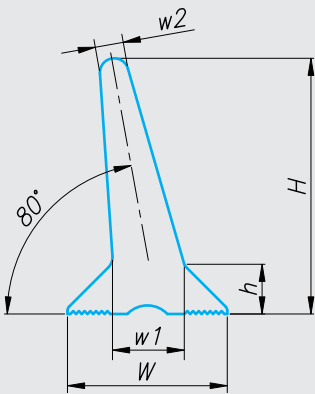

Colors available:

- White
- Petrol
- Apple green
- Dark green
- Light blue
- Dark blue
- Black

* on request

	H10S20	H10S30	H10S40	H10S50	H10S60	H10S70	H10S80
W	28	28	28	28	28	28	28
H	20	30	40	50	60	70	80
w1	9	9	9	9	9	9	9
w2	6	6	6	6	6	6	6
h	9	9	9	9	9	9	9
**D drum	90	100	110	130	150	180	200

*all dimensions are in mm

**min. drum flexing

H-RF

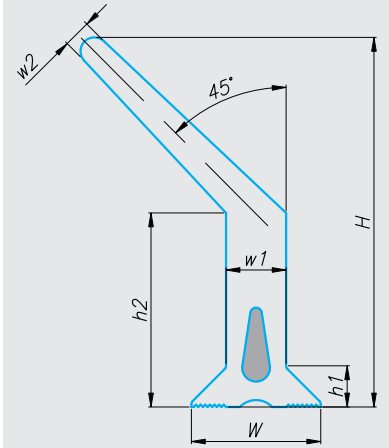
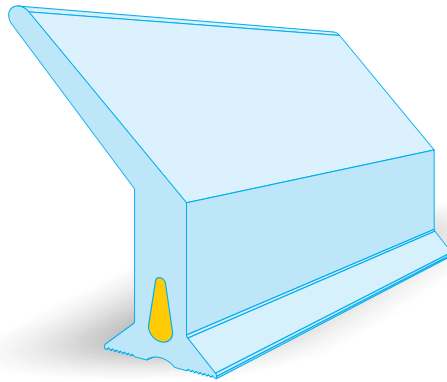

	H-RF70	H-RF80
W	28	28
H	70	80
w1	12	12
w2	7	7
h1	8	8
h2	40	40
**D drum	160	180

Colors available:

- White
- Petrol
- Apple green
- *Dark green
- Light blue
- *Dark blue
- *Black

* on request

TW

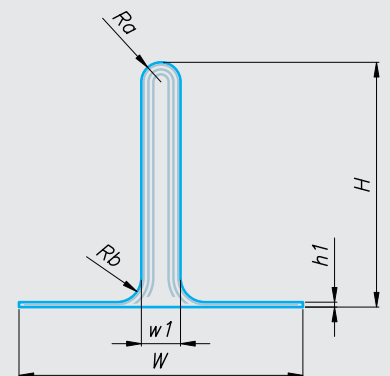
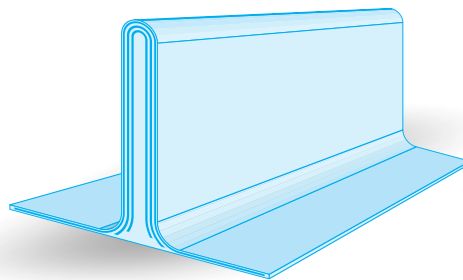

	TW20	TW30	TW40	TW50	TW60	TW75	TW100
H	20	30	40	50	60	75	100
W	58	58	58	58	58	58	58
w1	8	8	8	8	8	8	8
h1	1	1	1	1	1	1	1
Ra	4	4	4	4	4	4	4
Rb	5	5	5	5	5	5	5
**D drum	100	100	100	100	100	100	100

Colors available:

- White
- Petrol
- Apple green
- *Dark green
- Light blue
- *Dark blue
- *Black

* on request

On request, different structures are possible.
*all dimensions are in mm; **min. drum flexing



PVC CLEATS

HWK

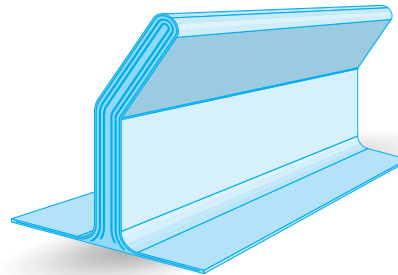
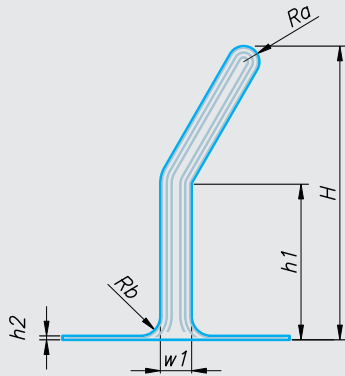

Colors available:

- White
- * Petrol
- Apple green
- Dark green
- Light blue
- * Dark blue
- Black

* on request

	HWK40	HWK50	HWK60	HWK75	HWK100
H	40	50	60	75	100
W	58	58	58	58	58
w1	8	8	8	8	8
h1	15	15	40	40	40
h2	1	1	1	1	1
Ra	4	4	4	4	4
Rb	5	5	5	5	5
**D drum	100	100	100	100	100

K

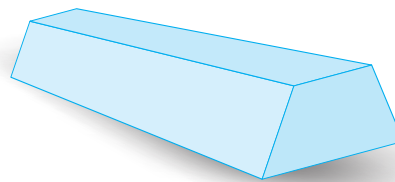
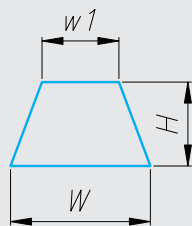

Colors available:

- White
- * Petrol
- Apple green
- Dark green
- Light blue
- * Dark blue
- Black

* on request

	6x4	8x5	10x6	13x8	17x11	22x14	30x16
H	4	5	6	8	11	14	16
W	6	8	10	13	17	22	30
w1	4	5	5,5	7,5	9,5	12,5	20
**D drum ¹	35	45	55	70	90	120	130
**D drum ²	40	60	80	100	120	150	180
**D drum ³	40	50	80	100	120	150	180

Fastening versions:

- ¹ longitudinal - bottom
- ² longitudinal - top
- ³ as lateral carrier

*all dimensions are in mm

**min. drum flexing

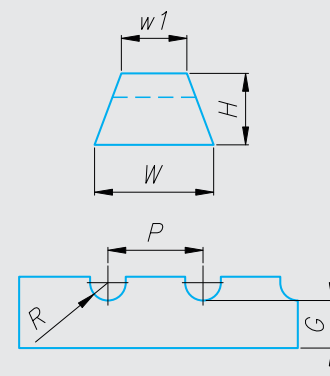
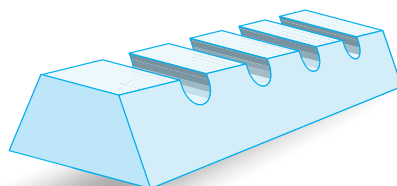

	6x4	8x5	10x6	13x8	17x11
H	4	5	6	8	11
W	6	8	10	13	17
w1	4	5	5,5	7,5	9,5
P	6	8	8	10	12
R	1,5	1,5	1,5	1,5	2,5
G	2,5	3	4	5,5	6,5

Fastening versions:

¹ longitudinal - bottom

² longitudinal - top

³ as lateral carrier

**D drum ¹	30	35	40	50	75
**D drum ²	35	55	75	95	115
**D drum ³	35	45	75	95	115

Colors available:

- White
- Petrol
- Apple green
- Dark green
- Light blue
- Dark blue
- Black

* on request

SIDEWALL

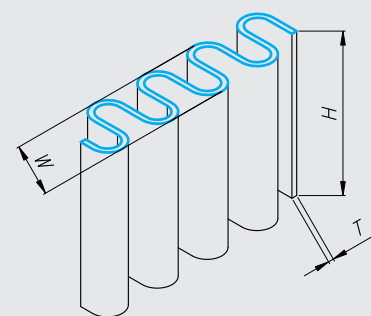
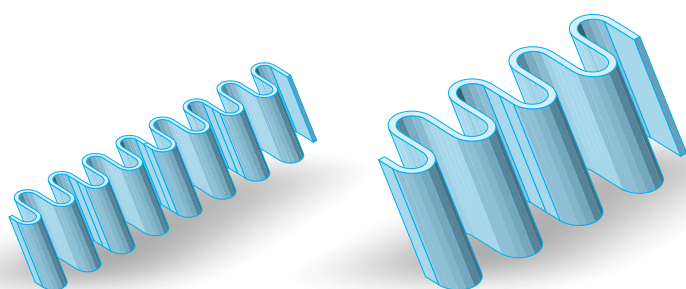

	BIG									
H	25	30	40	50	60	70	80	90	100	
T	3-5	3-5	3-5	3-5	3-5	3-5	3-5	3-5	3-5	3-5
W	45	45	45	45	45	45	45	45	45	45
**D drum	60	90	120	150	180	210	240	270	300	
	SMALL									
H	25	30	35	40	45	50	55			
T	2	2	2	2	2	2	2			
W	22	22	22	22	22	22	22			
**D drum	50	60	70	80	90	100	110			

Colors available:

- White
- Petrol
- Apple green
- Dark green
- Light blue
- Dark blue
- Black

* on request

*all dimensions are in mm; **min. drum flexing



SCHIKI

MOVING YOU FORWARD.



PU CLEATS

- | High flexibility even at low temperatures
- | Very good resistance to oil and grease
- | Good wear resistance
- | Suitable for contact with all foods
- | Available in many colors and profiles versions
- | Resistance to chipping

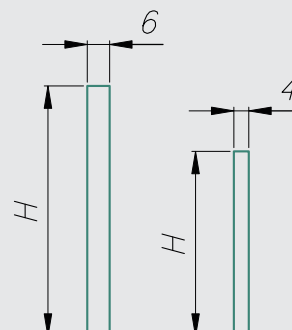
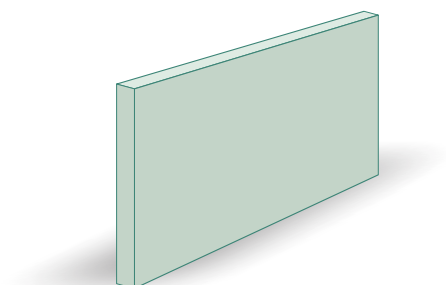

		SP4							
H		10	15	20	25	30	40	50	60
**D drum		50	50	50	50	50	50	50	60

		SP6										
H		10	15	20	25	30	40	50	60	70	80	90
**D drum		80	80	80	80	80	80	80	80	100	100	100

Colors available:

- White
- Petrol
- Apple green
- Dark green
- Light blue
- Dark blue
- Black

* on request

OPTION 75°

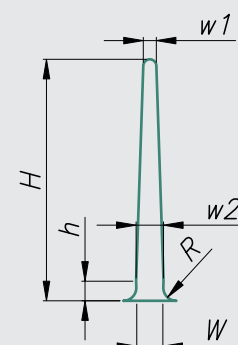
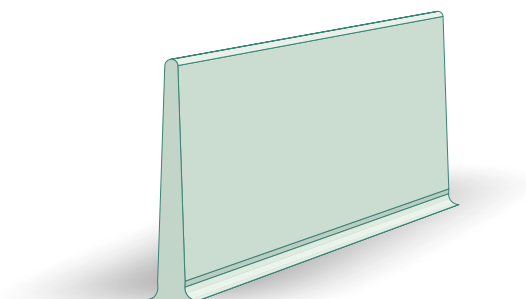
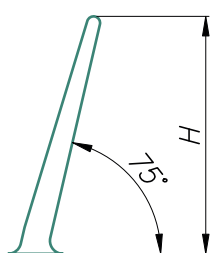

	PN20	PN35	PN50	PN75
W	3	4	5	6
W	20	35	50	75
w1	2	2	2	2
w2	3,2	3,2	5,2	6,2
h	3	3	3	3
R	2	2	2	2
**D drum	30	45	60	90

Colors available:

- White
- Petrol
- Apple green
- Dark green
- Light blue
- Dark blue
- Black

* on request

*all dimensions are in mm

**min. drum flexing



PU CLEATS

UV

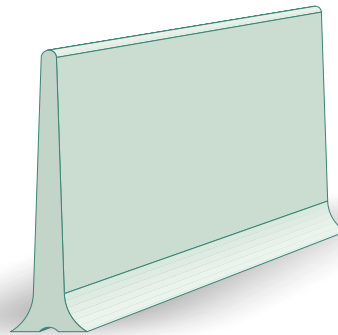
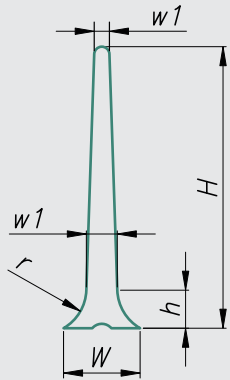

Colors available:

- White
- * Petrol
- * Apple green
- Dark green
- Light blue
- * Dark blue
- * Black

* on request

	UV20	UV30	UV40	UV50	UV60
W	10,5	10,5	10,5	10,5	10,5
H	20	30	40	50	60
w1	3	3	3	3	3
w2	6	6	6	6	6
h	5	5	5	5	5
r	6	6	6	6	6
**D drum	40	45	50	60	100

UL

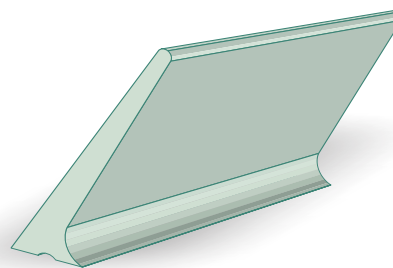
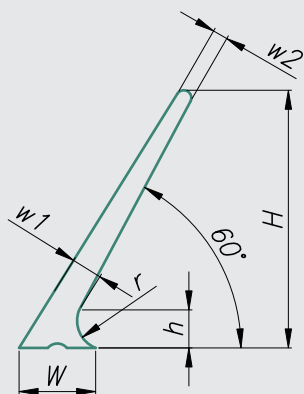

Colors available:

- White
- * Petrol
- * Apple green
- Dark green
- Light blue
- * Dark blue
- * Black

* on request

	UL30	UL40	UL50	UL60
H	10,5	10,5	10,5	10,5
W	30	40	50	60
w1	4	4	4	4
w2	6	6	6	6
h	5	5	5	5
r	5	5	5	5
**D drum	40	50	60	80

*all dimensions are in mm

**min. drum flexing

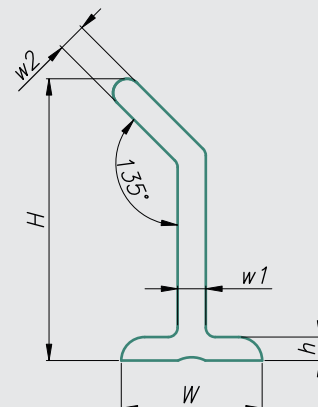
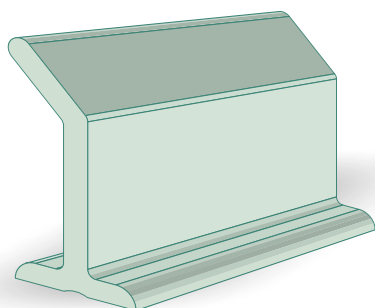

	DI20	DI30	DI40	DI50	DI60	DI70	DI80
H	15	15	15	15	15	20	20
W	20	30	40	50	60	70	80
w1	3	3	3	3	3	3,5	3,5
w2	3	3	3	3	3	3,5	3,5
h	2,5	2,5	2,5	2,5	2,5	3	3
**D drum	65	65	65	65	65	95	95

Colors available:

- White
- Petrol
- Apple green
- Dark green
- Light blue
- Dark blue
- Black

* on request



PU CLEATS

K

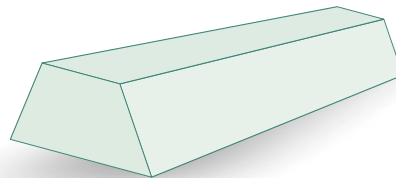
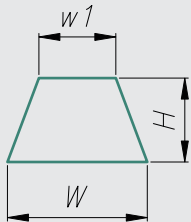

Colors available:

- White
- * Petrol
- Apple green
- Dark green
- Light blue
- Dark blue
- Black

* on request

	6x4	8x5	10x6	13x8	17x11
H	4	5	6	8	11
W	6	8	10	13	17
w1	4	5	5,5	7,5	9,5
**D drum ¹	50	60	70	90	100
**D drum ²	50	70	90	110	130
**D drum ³	50	60	80	100	130

Fastening versions:

- ¹ longitudinal - bottom
- ² longitudinal - top
- ³ as lateral carrier

KN

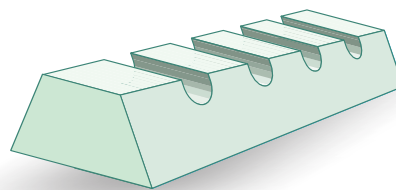
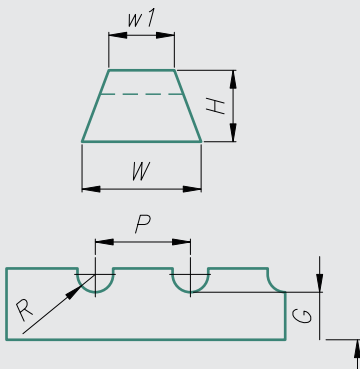

Colors available:

- White
- * Petrol
- Apple green
- Dark green
- Light blue
- Dark blue
- Black

* on request

	6x4	8x5	10x6	13x8	17x11
H	4	5	6	8	11
W	6	8	10	13	17
w1	4	5	5,5	7,5	9,5
P	6	8	8	10	12
R	1,5	1,5	1,5	1,5	2,5
G	2,5	3	4	5,5	6,5
**D drum ¹	30	35	40	60	80
**D drum ²	45	65	85	105	125
**D drum ³	40	50	80	100	120

Fastening versions:

- ¹ longitudinal - bottom
- ² longitudinal - top
- ³ as lateral carrier

*all dimensions are in mm; **min. drum flexing

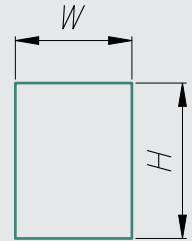
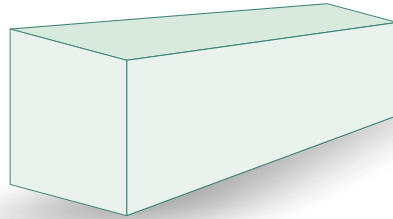

	8x8	10x10	12x12	15x12	15x15	15x20	15x25	15x30	20x20
H	8	10	12	15	15	20	25	30	20
W	8	10	12	12	15	15	15	15	20
**D drum	100	130	130	140	140	140	150	180	200

Colors available:

- White
- Petrol
- Apple green
- Dark green
- Light blue
- Dark blue
- Black

* on request

SIDEWALL

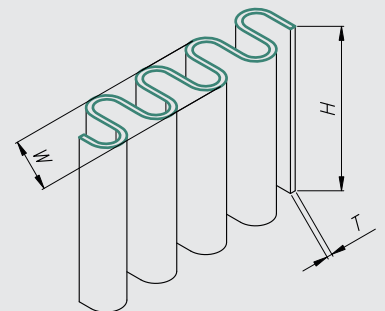
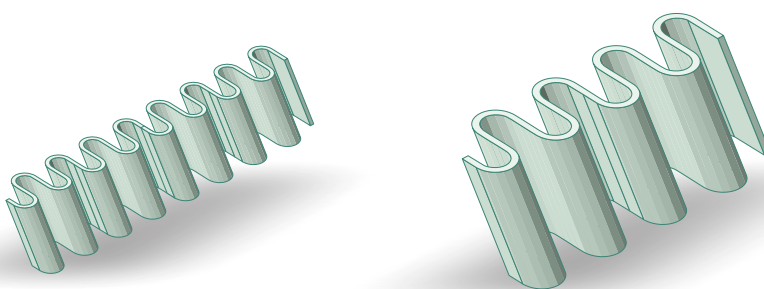

	BIG									
H	25	30	40	50	60	70	80	90	100	
T	3-5	3-5	3-5	3-5	3-5	3-5	3-5	3-5	3-5	3-5
W	45	45	45	45	45	45	45	45	45	45
**D drum	75	90	120	150	180	210	240	270	300	

Colors available:

- White
- Petrol
- Apple green
- Dark green
- Light blue
- Dark blue
- Black

* on request

	SMALL							
H	25	30	35	40	45	50	55	
T	2	2	2	2	2	2	2	
W	22	22	22	22	22	22	22	
**D drum	50	60	70	80	90	100	110	

*all dimensions are in mm; **min. drum flexing

More information about products and services
can be found on our website:

www.schiki.si / www.schikelbelting.com



MOVING YOUR BUSINESS
FORWARD.



SCHIKI
MOVING YOU FORWARD.

Schiki d.o.o.
Grajska ulica 11
3210 Slovenske Konjice

T +386 (0)3 757 23 50
E info@schiki.si
W www.schikelbelting.com

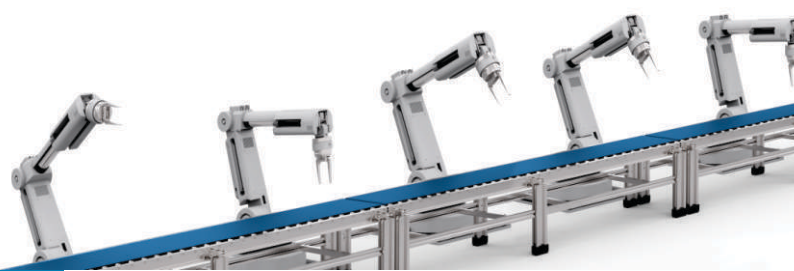

© Schiki d.o.o.
The data presented may be subject to change due to continuous development. These data replace those included in previous publications.
Schiki d.o.o. excludes any liability for misuse of the above data.
All activities and services provided by Schiki d.o.o. are in accordance with the general terms and conditions of sale and delivery.